



FlighttechSystems[®]

www.flighttech.es

Flighttech Systems Europe, S.A. (Flighttech)

The corporate purpose of **Flighttech**, incorporated in December 2006, consists of the technological research and development of remotely piloted aerial vehicles, as well as the design, manufacture and sale of these for any civilian use, whether in the security, scientific, environmental, meteorological or research field.

Its technical team is comprised of personnel with vast experience in the aeronautical sector, having developed prototypes from jet propulsion aircraft through seaplanes, as well as airborne electronic systems.



Flighttech RPA's and mobile units.

For the past 5 years **Flighttech** has been developing the **FT-ALTEA**, the first RPA with an Experimental Airworthiness Certificate with registration EC-008, issued by AESA (State Aviation Safety Agency).

AERONÁUTICOS, Magazine of the Official Association of Aeronautical Engineers.

"Flighttech Systems was the first company to obtain airworthiness certification by means of an unprecedented solution: A high-technology UAV, project FT-Altea, developed, among other purposes, for extinguishing forest fires."

The success of the project was made possible thanks to several agreements for collaboration with enterprises and organizations of the sector that have allowed us to manufacture the first fleet of RPA's with Airworthiness Certificates, among which the following are worthy of note:

- **Aernnova**: is a company of aerostructures that assumes the integral management of large aircraft sections. It participates in the design and manufacture of parts and structures for Airbus, like the new **Airbus A380**, and also for Boeing, as in the case of the **Boeing 747-LFC**. It works for **Flighttech** in the manufacture of **FT-ALTEA** aircraft fuselages, guaranteeing the most rigorous quality controls and the most advanced techniques with composite materials applied in aeronautics.

- **The State Aviation Safety Agency (AESA) and the Directorate General of Civil Aviation (DGAC)** have been working on the development of legislation for UAS since 2006, when **Flighttech** presented the **FT-ALTEA** file for its certification.
- **Uría & Menéndez:** Represents **Flighttech**, particularly before the aeronautical authorities. It is one of the most prestigious law firms in Europe and its knowledge management system is recognized as one of the 10 best of Europe. Its international recognitions include: the European Law firm of the Year” in the British Legal Awards 2010, “Best Law Firm in Spain”, and the Chambers Europe Awards 2010. Uría Menéndez.
- **Deloitte:** Has audited Flighttech since the start of the company.
- **INTA: National Institute of Aerospace Technology,** with an extensive Test Laboratory to qualify systems. **Flighttech** makes use of the Laboratories to obtain, among others, EMC qualifications (Electromagnetic compatibility trials); qualification of environmental conditions such as moisture, temperature, dust, etc.
- **Embention:** Company devoted to the development of systems for forest fire extinguishment.

One of the main missions of Flighttech in the civilian sector is to provide solutions for the growing problem of deforestation caused by fires, with relevant impact within the national fire protection program since it will furnish the only RPAS with airworthiness certificates to perform these tasks.



Part of the F-T ALTEA RPA fleet

FT-ALTEA

The **Flighttech** RPA is a high technology aircraft whose components were designed and developed especially for observation and surveillance. The aircraft was designed in its entirety by **Flighttech**.

The **FT-ALTEA** is a vehicle with a wingspan of 6 meters and a maximum take off weight (MTOW) of 80 kg. It has a high wing and H-tail configuration and a propeller engine. Takeoff and landing are performed from the ground without any additional launch system. The vehicle is equipped with a control and communications system operated from the ground.



FT-ALTEA fleet and mobile unit

The main features of the **FT-ALTEA** are:

- Automatic takeoff, flight operations and landing.
- Autonomy in excess of 4 flight hours.
- Latest generation, light and efficient composite materials, such as carbon fiber.
- Sensors/actuators adapted to client needs.
- High immunity against adverse atmospheric conditions.
- Autonomous Navigation System by waypoints modifiable in real time.
- Communications systems of high reliability, encryption and range.
- High quality video recording systems.
- Thermal camera.
- Certified anti-collision lights.
- Mode S Transponder.
- Connection with the closest control tower for air traffic control.
- Autonomous emergency parachute system and redundant activation system.

Control Station (GCS)

The control station (GCS) of the **FT-ALTEA** is comprised of a set of equipment and systems that assume mission planning and control tasks (flight control, payload control), information distribution or dissemination to external or end users, communications with the assigned control tower.



Control station (GCS)

The ground station includes communications systems and data links necessary to access the platform and airborne systems. These controls are necessary, at minimum, to define and supervise the mission. The GCS is composed of the hardware and human means that direct and control the mission from the base station. It may be located on land, at sea or in the air and may be a fixed site or mobile unit.

The functions that it performs are the following:

- **Mission planning.** The mission is comprised basically of the definition of the flight plan to be followed and the actions that should be executed.
- **Communication with the RPA.** To transmit the orders and receive telemetry, with speed, altitude and position data, directional and omnidirectional antennas are used with redundant radio modems.
- **Payload.** The payload is composed of electro-optical vision and infrared or thermal vision, and may also include temperature, moisture, CO2 sensors, hyperspectral cameras and other sensors. The sensors and airborne systems may collect a large quantity of information and send it to the station in real time.

The mission is executed by the autonomous flight control system. It should be considered that, although the UAV flies autonomously, it is always possible to take control from the control station (GCS).



FT-ALTEA landing.

In addressing a mission it is important to consider the **return route** necessary so that, at all times, during the flight, the aircraft knows how to return to the base if the mission is aborted.

In the ground station data entries, aerodynamic modules and the basic maneuvering parameters such as landing, reconnaissance operations are controlled...

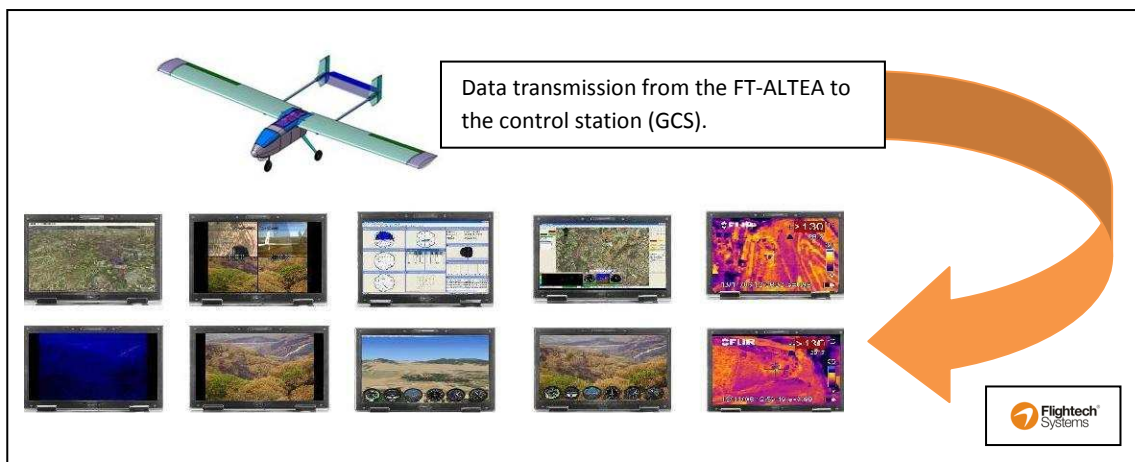

The information is encrypted and transmitted to ground control.

All information collected by the **FT-ALTEA** during a mission is recorded in the ground station and may furthermore be received at any other point the client wishes. For data transmission **Flighttech** utilizes the most innovative digital technologies.

The Flighttech surveillance and detection system

Remote piloted aircraft offer a unique opportunity: to establish a constant flight system, capable of real time “surveillance” of any geographical area or industrial installation. The **Flighttech** UAS system is based on very lightweight aircraft, capable of landing and taking off in highly reduced spaces and with great operability.

The RPA system developed by **Flighttech** is based on four pillars:

1. A network of unmanned aircraft.
2. An aerial imaging system with a great capacity for observation.
3. An efficient and instantaneous system for the transmission of images to a ground unit and via internet to any other point.
4. A land-based image analysis system to facilitate decision-making if any incident is identified.

Flighttech has the latest technology in the field of high resolution thermal and electro-optical cameras, using a dual viewing system to guarantee detection.

The image capturing system allows:

- Remote camera control.
- HD (high definition) image recording.
- Geo-pointing with the cameras.
- Right/left – upward/downward movement with the joystick.
- Image stabilization by inertial system.
- Creation of automatic flight patterns.
- Payload up to 12 Kg. totally adapted to the client.
- Daytime/nighttime surveillance support.
- 30-micron thermal camera.
- Human activity detection up to 1,800 meters.

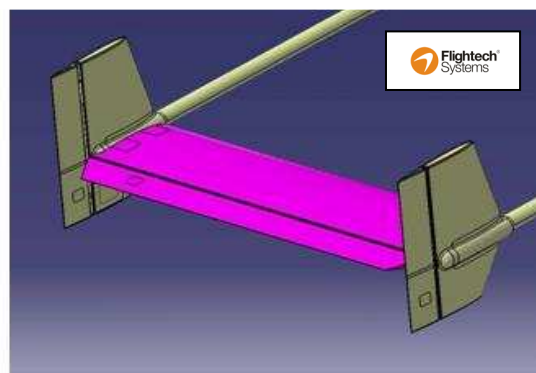
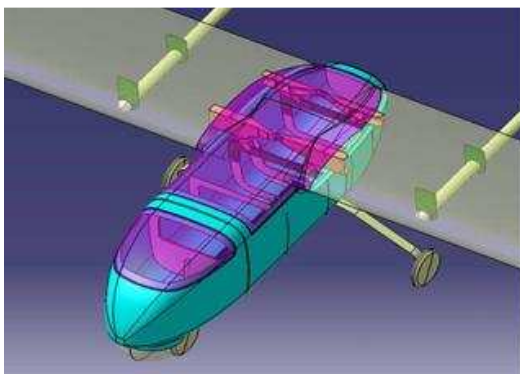

The FT ALTEA components were designed and developed especially for observation and surveillance.

CERTIFICATE OF REGISTRATION AND AIRWORTHINESS

Marcas de nacionalidad y matrícula
Nationality and Registration Marks

CERTIFICADO DE MATRÍCULA

Fecha de matriculación / Registration date

Certificate of Registration

21/01/2014

EC- LYG

Fabricante, Marca, tipo-modelo
Manufacture and Manufacture's designation of aircraft

Número de Serie / Serial number

**FLIGHTTECH SYSTEMS EUROPE
FLIGHTTECH ALTEA-EKO**

1

Propietario: FLIGHTTECH SYSTEMS EUROPE, S.A.
Owner

Domicilio/Address C/ JOSEFA VALCARCEL, 8 - 3º
28027 MADRID - ESPAÑA

Estacionamiento Habitual: Aerodromo de Casarrubios del Monte (Toledo)
Habitual Base

Se certifica que la aeronave arriba indicada ha sido inscrita en el Registro de Matrícula de Aeronaves del Reino de España de conformidad con el Convenio de Aviación Civil Internacional del 7 de diciembre de 1944, Ley 48/1960 de 21 de julio sobre Navegación Aérea y el Reglamento del Registro. / It is hereby certified that the above described aircraft has been duly entered on the Spanish Civil Aircraft Register in accordance with the Convention on International Civil Aviation dated 7 December 1944, the Spanish Aviation Legislation in force (Law 48/1960 of 21 July) and the regulations which govern the Spanish Civil Aircraft Register.

Fecha de expedición / Date of issue

Madrid, 21 de enero de 2014

Firmado Electrónicamente por / Electronically Signed by
El Director de Seguridad de Aeronaves / Director, Aircraft Safety
P.D.F. (Resolución de fecha, 8 de octubre de 2013)/By delegation (Decision 8th October 2013)
El Jefe Sustituto del Registro / Deputy-Chief of Aircraft Register
Loreto Serrano de Pablo Díez



ESTE CERTIFICADO DEBE LLEVARSE A BORDO DE LA AERONAVE
This certificate must be carried onboard the aircraft

Identificador electrónico / Document ID: AESAURMACERT0001576E6C9DA
Permite la comprobación de este documento, en la dirección / Allows to check this document on:
<https://www.seguridadaerea.gob.es> > Sede Electrónica (Oficina virtual) > Comprobación documental



ESPAÑA
AGENCIA ESTATAL DE
SEGURIDAD AÉREA

CERTIFICADO DE AERONAVEGABILIDAD ESPECIAL RESTRINGIDO

| | | |
|---|---|-------------------------------|
| 1) Nacionalidad y matrícula. EC-LYG | 2) Constructor y designación de la aeronave. FLIGHTTECH ALTEA-EKO | 3) Nº de serie. 001 |
|---|---|-------------------------------|

4) Categorías: PRIVADO (3) ESPECIAL

5) *El presente Certificado de Aeronavegabilidad, se otorga de acuerdo con la Reglamentación de la Agencia Estatal de Seguridad Aérea (AESA), según Instrucción Circular 11-05A, DDC.2013 Ed.3 de fecha (16/07/2014) de la Agencia Estatal de Seguridad Aérea, para la aeronave antes mencionada, que se considera reúne las condiciones de aeronavegabilidad, mientras se mantenga y utilice de acuerdo con lo que antecede y las limitaciones de utilización pertinentes.*

Madrid, 21 de Julio de 2014
EL DIRECTOR DE SEGURIDAD DE AERONAVES
P.D.F. (Resolución de L.D.S. de 27 de octubre de 2008)
EL DIRECTOR DE LA OFICINA DE SEGURIDAD EN VUELO Nº 6

Marcelino Pazos Lameiro

OPERATING PROFIT OF FT-ALTEA

FT-ALTEA Applications

The applications of the RPAS are several. A network of RPA's may be deployed to monitor the borders or large infrastructures such as power lines or nuclear power stations. The information is sent to surveillance posts and/or control centers from where the images of the target tracked are received in real time. The position of the target is represented on a digital map.

Changing the path of the RPA is as easy as using the mouse to "click" on the point of the map around which aircraft orbit is desired. Pre-programmed flight paths make it possible to continuously and efficiently sweep one same area.

They are highly efficient for environmental surveillance. They are able to measure the location, surface area and displacement of oil spills at sea. In fires, biological or nuclear disasters they are able to closely observe the location of the catastrophe without endangering human lives. They are ideal for seeking and locating shipwrecks...

| Service | Image | Description |
|--------------------|-------|-------------|
| CARTOGRAPHY | | |

Orthophoto

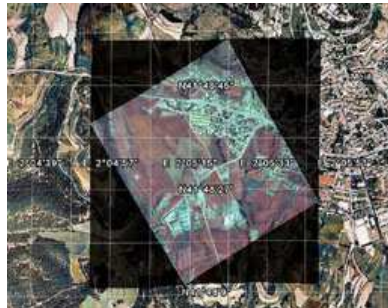

Making orthophoto maps of municipalities, urban centers, natural parks and agricultural and forest lands.

Altimetry

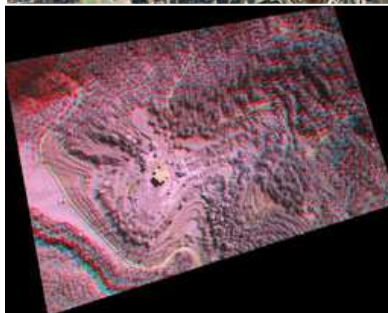

Making high resolution models of ground elevations. Height calculation of ground elements.

AGRICULTURE

Management of crops, nurseries and plantations

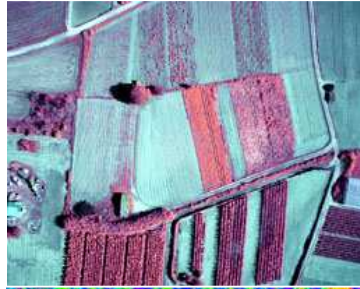

Control and monitoring of the condition of the crops by multispectral images.

Evaluation and comparison of biophysical parameters

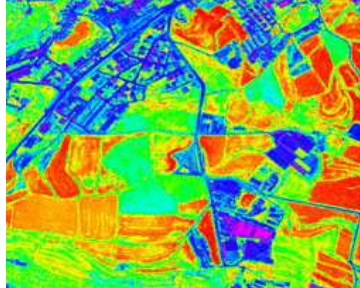

Derivation of biophysical parameters using multispectral images and their temporal variability on the basis of the phenological evolution of the crops.

Control of irrigation efficiency

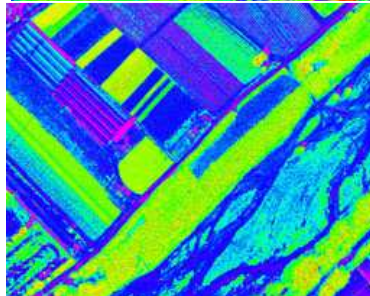

Irrigation efficiency manifests itself by positive correlation with the normalized vegetation index defined with multispectral images from RPA's. The observations may be programmed on the basis of the irrigation policies implemented.

FORESTRY

Evolution and monitoring of forests



Monitoring the condition of woodland areas by means of multispectral images.

Measurement and evolution of tree density and height

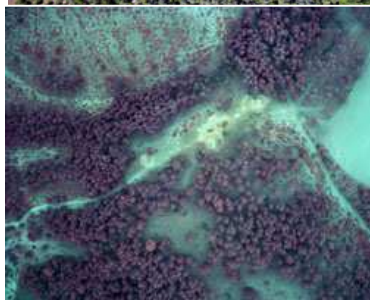

Quantification of the density, distribution and volume of different tree species by means of series of multispectral images and stereoscopic techniques.

Evaluation and comparison of biophysical parameters

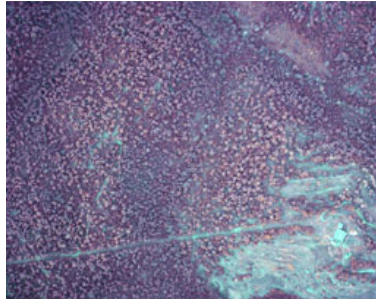

Derivation of biophysical parameters using multispectral images and their variation on the basis of the phenological evolution of each type.

Identification of species in large wooded areas

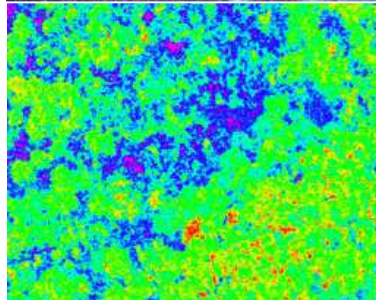

Forest classification using multispectral images and their temporal variation on the basis of the seasonal evolution of each type.

Plague monitoring and evaluation

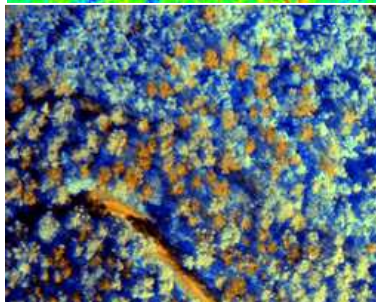

Plague identification and the study of their extension and evolution by means of multispectral images and their temporal variation.

Fires

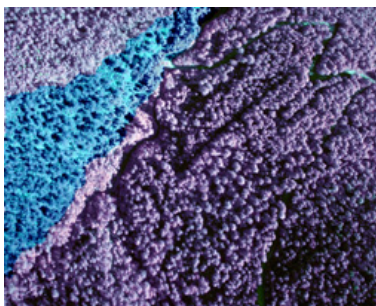

Monitoring of drought conditions in forests. Support to the coordination of extinguishment tasks. Control of the evolution of fires in real time from the ground. Efficient calculation of the perimeter and the extension and degree of calcination of the burned forest.

VITIVINICULTURE

Monitoring of vineyards

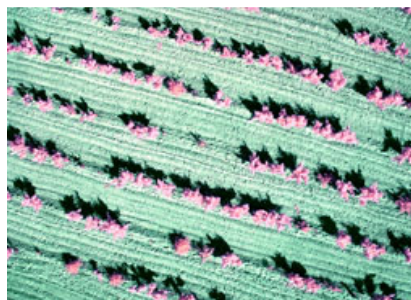

Detailed monitoring of vineyards, vine to vine, using multispectral images and their variation throughout the entire phenological cycle.

Support to precision viticulture

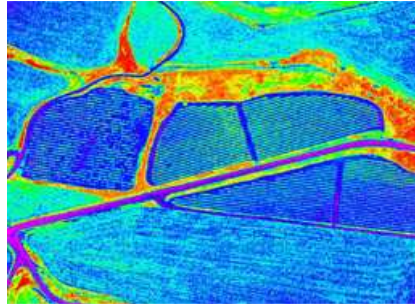

By means of a series of multispectral images: Quantification of the effect, vine to vine, of the application of irrigation, phytosanitary products, etc., and the optimization of these resources. Precise determination of harvest time on the basis of the degree of grape bunch ripeness.

Damage quantification

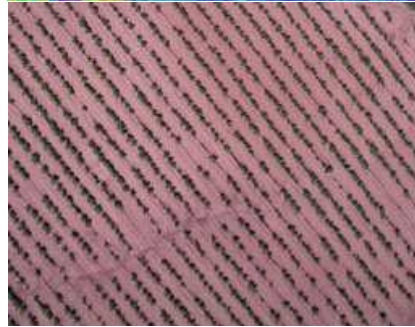

Precise quantification of vineyards affected by meteorological and extreme climate incidents (hail, frost, wind, drought, etc.) or by plagues and contamination.

GEOLOGY

Cartography

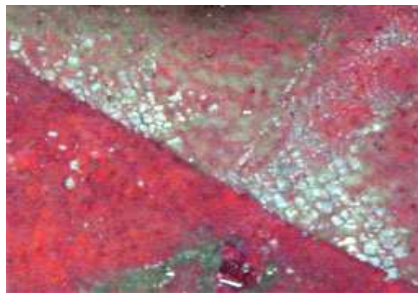

Capture of multispectral images for the preparation of centimeter resolution geological, sedimentological, mineralogical and geophysical maps.

Mining



Control and monitoring of mines and their environmental impact: soil movements, arid soil production, metallic residue, decanting basins, etc.

Geological risks: landslides, flooding, etc.



By multispectral images, determination and a centimeter scale of areas with associated geological risks: landslides, flooding, etc.

Geological risks:
avalanches

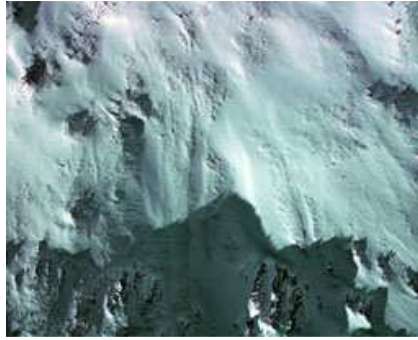

Characterization of areas with avalanche risks using multispectral images to determine the moisture of the snow, thermal cameras to determine its temperature and stereoscopic techniques to determine thicknesses.

HYDROLOGY

Basin control

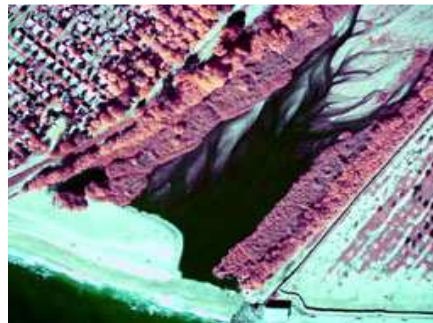

Analysis of the status of basin occupation, risk of flooding and basin estimation using a series of multispectral images and stereoscopic techniques.

Quantification of the condition of reservoirs

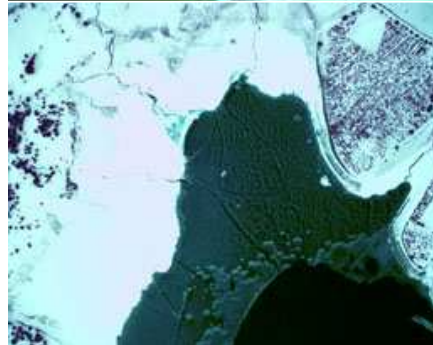

Quantification and monitoring of basins and reservoir reserves using visible and multispectral images with stereoscopic techniques.

Quantification of water reserves



Analysis of high mountain water reserves and estimation of melting flows using a series of multispectral images.

ENVIRONMENT

Light pollution



Parameterization of the light pollution index to prepare light pollution maps and monitor the efficiency of eco-energy measures. To do so a high-definition digital video is utilized. The multispectral analysis of these images allows the classification and statistics of the various sources of light. Determination of temperature and pressure

Condition of the atmosphere



tropospheric profiles and the quantification of the concentration of aerosols and gases by means of specific detectors: ozone, steam, CO2, etc. Solar radiation and albedo measurements. Detection of leaks of toxic gases and smoke.

Pollution and toxic spills in the aquatic and land environments

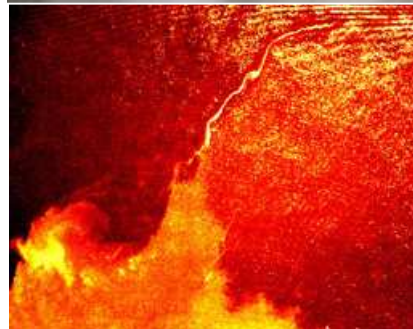

By means of multispectral images, control and monitoring of industrial accidents with toxic spills in aquatic and land environments. With the use of various spectral bands it is possible to record the presence of given contaminants on the surface.

Waste Management



Independent control of industrial waste deposit and storage and their treatment. The multispectral images allow the quantitative control of the environmental impact of dangerous materials and those that are difficult to recycle.

MANAGEMENT OF NATURAL SPACES

Recording and evolution of the landscape

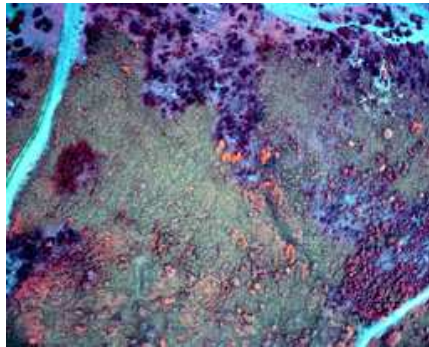

Creation of visible landscape files in Natural Parks, PEIN's and other protected areas. In addition to establishing records for the future, they make it possible to observe their evolution throughout the annual cycle and over time (evolution of crops, forests, anthropogenic modifications, etc.)

Planning and monitoring of reforestation

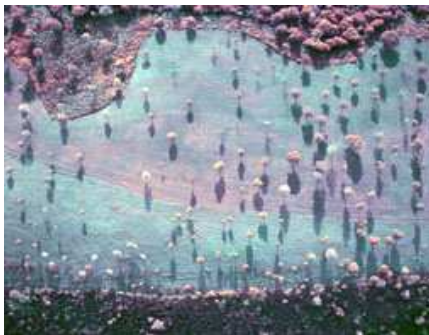

Monitoring of the reforestation and recovery of burned or degraded forests using multispectral images and the temporal evolution thereof.

Daytime and nighttime fauna observation in open spaces



The silent electric engines and the charging capacity of the RPA's make it possible to make daytime and nighttime observations of fauna in open spaces without interfering in their lives.

Impact evaluations



Studies of the environmental impact of opening roads or other infrastructures in natural spaces by means of multispectral images via RPA's.

PUBLIC WORKS

Impact evaluation



Analysis of the visual impact of infrastructures on large extensions of land by visible spectrum images captured by low-flying RPA's.

Control of civil works



Monitoring of the implementation of civil works that affect large extensions (roadways, channels, reservoirs, high-voltage lines, wind parks, etc.) using centimeter scale aerial images.

URBAN DEVELOPMENT

Urban management and planning



Observation and monitoring of constructions. High resolution photographic record from various perspectives or by video of urban areas associated with planning projects.

Control of illegal urban development



By means of multispectral and visible airborne images in RPA's, it is possible to detect illegal constructions in rural, forest and other areas of difficult access.

Management of green areas

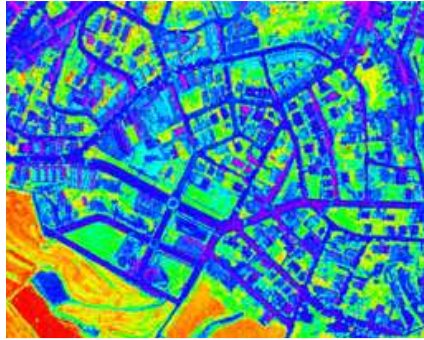

Monitoring of the condition of green areas and characterization of their interactions with adjacent urban areas by means of a series of multispectral and visible images.

TRAFFIC MOBILITY

Monitoring of roadway mobility



Monitoring traffic status. It is an efficient and value added alternative to the helicopter, eliminating risks to the personnel who broadcast traffic conditions and making it possible to digitally record the daily status of traffic, in addition to being much more economic and sustainable (non-contaminating).

CIVIL PROTECTION

Function integration and centralizations



The coordination of functions that extend in space and are concentrated in time may constitute a critical task in large events. The control and saturation of accesses by foot and by car, the monitoring of the flow of people, the location of parking areas and any incident may be coordinated and transmitted easily to users with the help of RPA's.

Cultural demonstrations in open spaces and urban centers



Monitoring of people in real time. Control of incidents in the urban environment.

Rescue team support

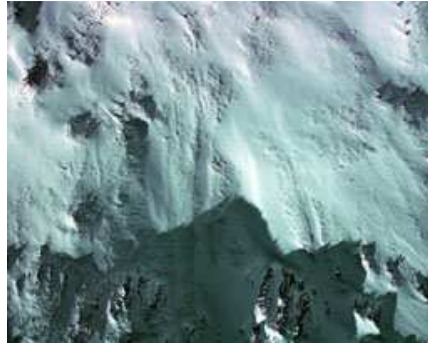

Victim detection in areas of geological risks: avalanches, earthquakes, floods, landslides. Development of nocturnal detection systems for persons as well as for daily rescue support. Detection of persons and elements with radio beacons.

CULTURE

Cultural Heritage Management



Characterization of the state of preservation of cultural heritage elements and the control of their changes by means of high resolution photographic records from RPA's.

Archeology



Support to archeological digs and prospecting. The high resolution and multispectral photography of sites improves documentation and may furnish information to interpret vegetation responses to structures beneath the surface.

SECURITY

Image service. Description high resolution surveillance



During daytime and nighttime services, detection of persons and objects on land and at sea, monitoring of mobile objects without the possibility of detection and flying over and recording infrastructures and various situations.

UAV ALTEA TECHNICAL SPECIFICATIONS



SIZES AND DIMENSIONS

| | |
|------------------------|-------------------|
| WINGSPAN | 6.151m |
| LENGTH | 3.207m |
| FUSELAGE HEIGHT | 0.413m |
| FUSELEGE WIDTH | 0.400m |
| WING AREA | 3.6m ² |
| WEIGHT | 80Kg |

TECHNICAL SPECS

| | |
|---------------------------------|---------------------------|
| MAX. FLIGHT TIME | 4h |
| MAX. HEIGHT | 5000m |
| OPERATION SYSTEM | |
| RADAR DETECTION | YES |
| TRANSMISSION IMAGES | REAL TIME AND DVD QUALITY |
| OPTICAL &MULTI | OPTIONAL |
| HYPER SPECTRAL SENSORS | |
| DATA ENCRYPTION | YES |
| FUEL | 95-98 UNLOADED |
| PAYLOAD | 12Kg |
| RANGE IMAGES TRANSMISION | 100Km |
| | INFRARED |
| CAMARAS | NIGHTVISION |
| | THERMAL |

OTHERS INCLUDED IN PRICE

| | |
|----------------------------|---------|
| WARRANTY | 5 Years |
| TRAINING FOR PILOTS | Yes |

Details of Clarifications sought-Technical parameters on Drone manufactured by Flightech-Madrid (Spain)

1. Number of models of UAVs with their individual sizes and dimensions.

One model certified and with registration marks: Flightech Altea-Eko. These are the sizes and dimensions (section 1.3.2 of the Technical Description Document “TDD”):

- Wingspan: 6.151 m
- Length: 3.207 m
- Maximum height: 1.054 m
- Fuselage height: 0.413 m
- Fuselage width: 0.400 m
- Wing area 3.6 m²

2. Max flight time from take off to landing.

Four hours (1.3.9 TDD).

3. Area that can be covered in a single flight.

There are different possibilities depending upon the quality of the images and the terrain shape. We outline two examples:

- Example 1: High resolution image. An aircraft flying at cruising speed 120 km/h observing 500 m wide with the camera can monitor 60 km²/h. It makes 240 km² per 4 hours flight.
- Example 2: Low resolution image (greater observed area). If we increase the flying height and slightly the cruise speed, we would have not full resolution video image, but it might be valid for some surveillance uses. A plane flying at 135 km/h and watching 2,000 m wide with the camera can monitor 270 km²/h. It makes 1,080 km² per 4 hours flight.

4. Max height at which the UAV can fly.

1,521 m currently due to legal issues (1.3.8 TDD). However that limit can be raised easily.

5. Radar detection - Yes / No

The aircraft is able to be detected by primary or secondary radar.

6. Mode of transmission of images and information.

The images and information are transmitted by radio using two links (1.3.18 TDD):

- Command and control link:
Frequency: 902 - 928 MHz
Maximum output power: 1W (+30 dBm)
Range: 50 km line of sight, 0 dB gain antenna.



Channel separation: 230 kHz

The command and control link is tripled.

- Payload link:
Frequency: 2,4000 - 2.4835 GHz ISM band.

7. Facilities at ground station for receiving the info / images

The ground station integrates telemetry and remote control of the aircraft monitoring screens, joystick control, antennas and work area for the operators of the aircraft (1.3.1 TDD).

8. Suitable for what types of applications.

The applications are shown and explained in the Flightech presentation (pages 7 to 16).

9. Comparable to which international model of another manufacturer.

- Luna (EMT Penzberg, Germany)
- Hermes 90 (Elbit Systems, Israel)
- Sky Spirit (Lockheed Martin, USA)

10. Requirement of utilities for operation of the UAVs.

Electricity is recommended. However, our ground control unit has two generators.

11. Type of fuel used and details of payload.

- Fuel: 95-98 unleaded octane oil mixed 2-3% (1.3.5 TDD).
- Payload: it depends upon the mission of the aircraft. Its maximum weight is 12 kg (1.3.22 TDD). Some examples may be seen in pages 6 to 10 of the TDD.

12. Modality of data collection thru on board capsule or real time down links.

Both modalities (board memory and real time down link) are possible at same time.

13. Whether down link data is encrypted. If yes encryption details in terms of bits used.

The encryption is optional. We normally use it. Our current encryption uses a AES 128 bits. However, other encryptions are possible.

14. Confirm operating in free freq band. Otherwise we need to take permission from competent authorities.

The frequencies that Flightech operates in Spain are shown in point 6 before (1.3.18 TDD). However the radio modem can be adapted to operate in different frequencies.



15. Confirm Take off and landing is independent of the platform.

The aircraft does not need any launch or recovery systems. It automatically takes off and lands in a soil runway (1.3.20 TDD).

16. What are international standards followed for production of flight platform.

The international airworthiness standards prescribed by the Spanish civil aviation authority and followed were STANAG 4703 Light UAV Systems Airworthiness Requirements (USAR - LIGHT) for North Atlantic Treaty Organization (NATO) Military UAV Systems Draft Edition 1 March 2011, adapted to the spectrum and limitations defined in the technical description (1.2 TDD).

17. Please confirm whether these drones are being used for any military application.

They have not been used yet for military applications. However some of the potential clients are involved in military applications.

18. Modality of its return to base in event of guidance failure.

There are different possibilities in case of guidance failure. One of them is the continuation of the flight and then returning to base. Other is the return to base. Finally, the aircraft has a parachute for safe flight completion (1.3.21 TDD). The possibility chosen must be programmed before the flight.

19. Modality of after sale service during warranty period and beyond.

Flightech assumes a 5 year total warranty including components and maintenance.

BSS MATERIEL LIMITED

2/F Elegance Tower, Jasola District Centre
Mathura Road, New Delhi, India-110025

kaishot@bssm.limited www.bssm.limited

Flightech Systems. Sales Dpt.